

COLOUR CODE

9931

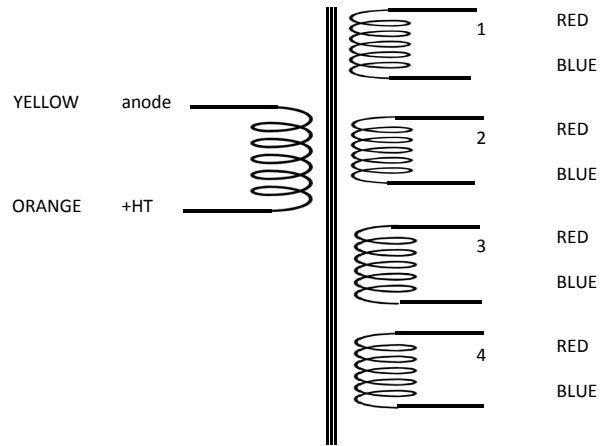

There are 4 equal secondaries that can be arranged for loads of 1, 4, 8/9 or 15/16 ohms thus:

