

**8896**

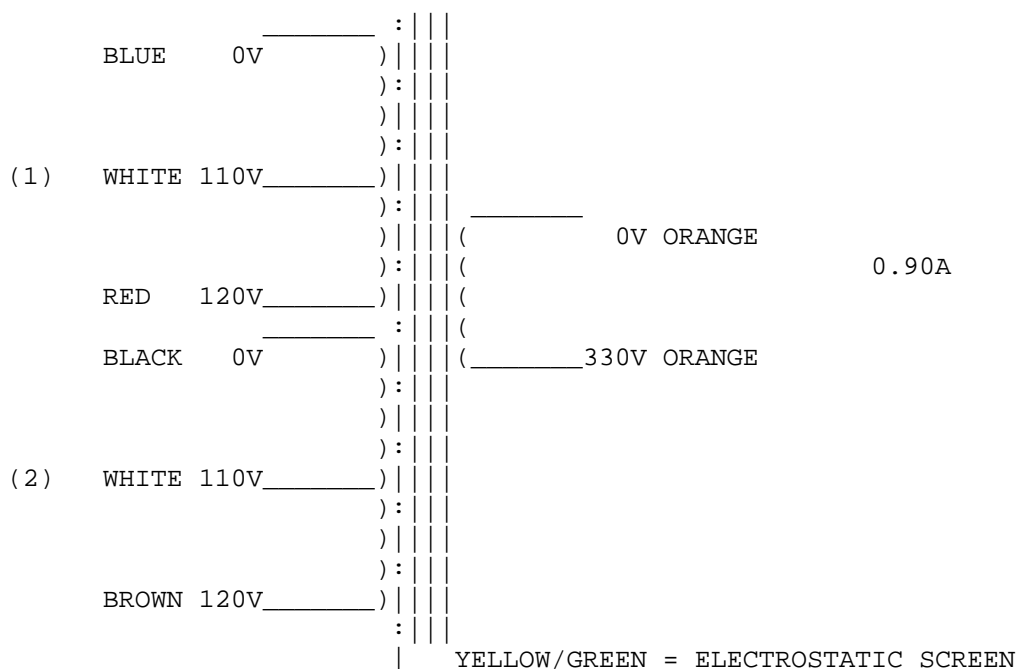

For 240V: Join RED & BLACK. Use BLUE & BROWN  
(Isolate both WHITES separately)

For 120V: Join BLUE & BLACK 0V and join RED & BROWN 120V.  
(Isolate both WHITES)

For 110V: Join BLUE & BLACK 0V and join both WHITES 110V.  
(Isolate RED & Isolate BROWN)

If the White leads are cut short please ensure the TWO wires  
inside the sleeving are joined together in BOTH cases.

Note: A certain amount of mechanical hum is prevalent in mains  
transformers and can be amplified when bolting to your metal work.  
Therefore you may find a small rubber casket or similar material  
is worth fitting to quieten this hum to its' minimum, but please  
ensure the frame is grounded to the supply safety earth.