

8653

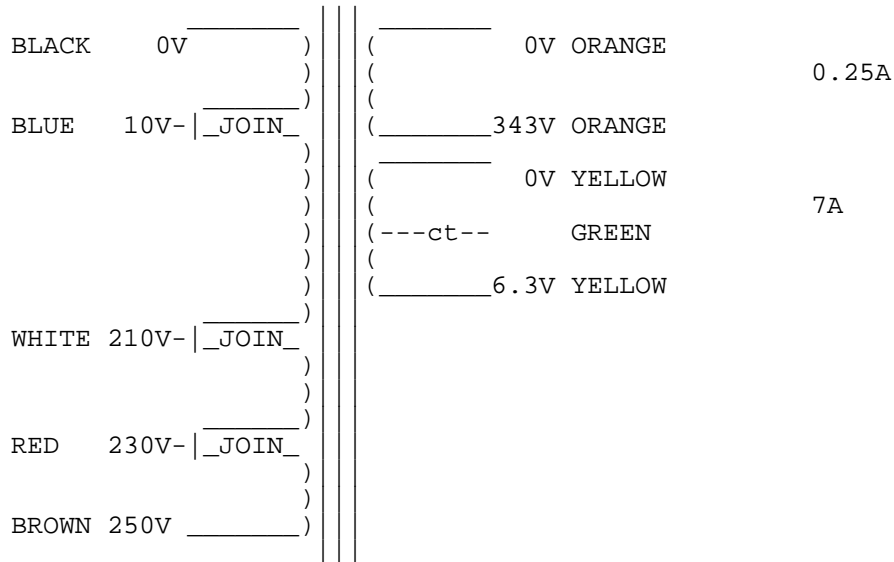

To obtain other inputs use as follows:

10V tap in place of 0V terminal thus:

BLUE/BROWN = 240V BLUE/RED = 220V BLUE/WHITE = 200V

You will note that the Primary is built up in sections and the two wires in the Blue, White and Red sleeves **must always be individually joined** to make the primary circuit complete. **Spare connections not required** can be cut short, **each colour joined separately and isolated**. The solid wire inside the sleeving is coated with polyurethane and needs to be **stripped away and tinned** if the leads are shortened.

Note: A certain amount of mechanical hum is prevalent in mains transformers and can be amplified when bolting to your metal work. Therefore you may find a small rubber gasket or similar material is worth fitting to quieten this hum to its' minimum.