

7490e



BLACK = ELECTROSTATIC SCREENS

1:1 Ratio = AB : DE

1:10.5 Ratio = AB : CE

7490e Lustraphone M10 Input Transformer 1:10 with a 1:1 tap

Ratio 1:10 with tap for 1:1 Max input level +9dBu. Sowter designed transformer replacement for the original Lustraphone transformer. Internal electrostatic shield to ensure good common mode noise rejection. Mumetal can 34 mm diameter with colour coded leads and threaded mounting boss.

7490f

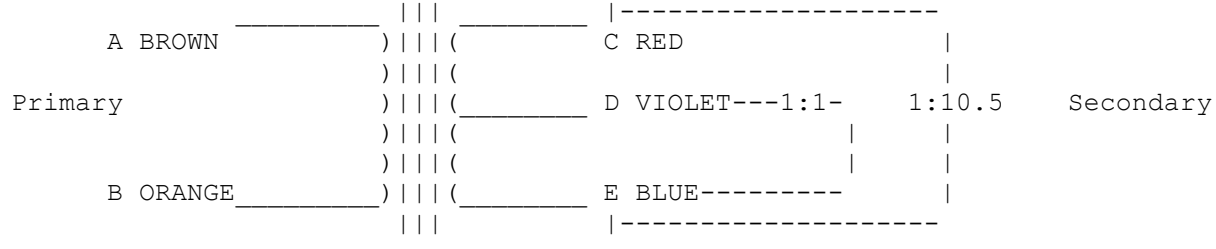

BLACK = ELECTROSTATIC SCREENS

1:1 Ratio = AB : DE

1:10.5 Ratio = AB : CE

DO NOT screw into transformer more than 3mm

7490f Input Transformer 1:10 with a 1:1 tap

Ratio 1:10.5 with tap for 1:1 Max input level +9dBu. Sowter designed transformer replacement for the original Lustraphone transformer. Internal electrostatic shield to ensure good common mode noise rejection. Low profile mumetal can

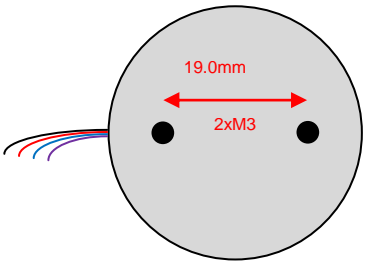
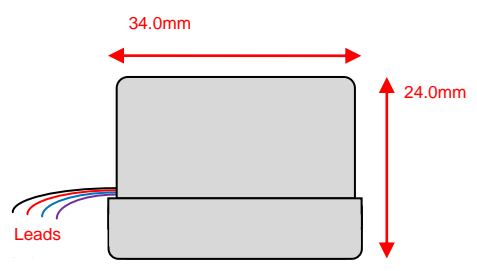

Style 'f' : 2xM3 Threaded Holes

7490f

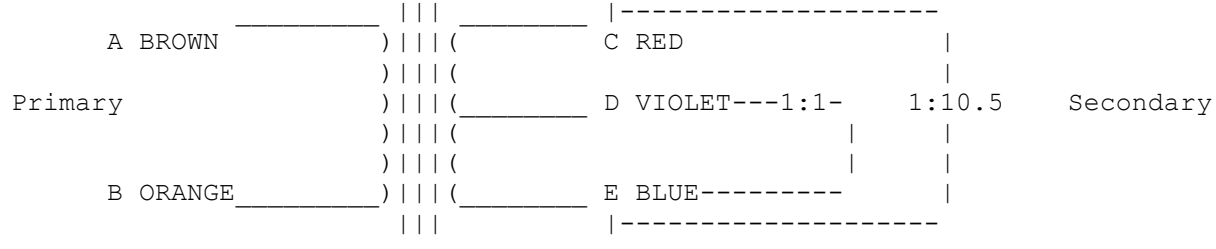

BLACK = ELECTROSTATIC SCREENS

1:1 Ratio = AB : DE

1:10.5 Ratio = AB : CE

DO NOT screw into transformer more than 3mm

7490f Input Transformer 1:10 with a 1:1 tap

Ratio 1:10.5 with tap for 1:1 Max input level +9dBu. Sowter designed transformer replacement for the original Lustraphone transformer. Internal electrostatic shield to ensure good common mode noise rejection. Low profile mumetal can

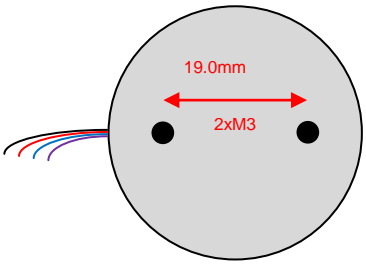
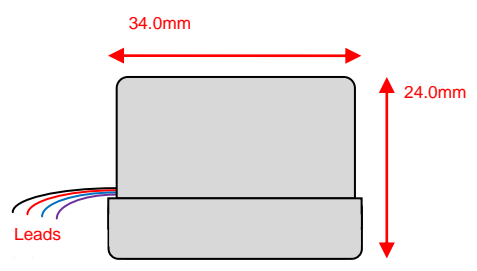

Style 'f' : 2xM3 Threaded Holes

7490x

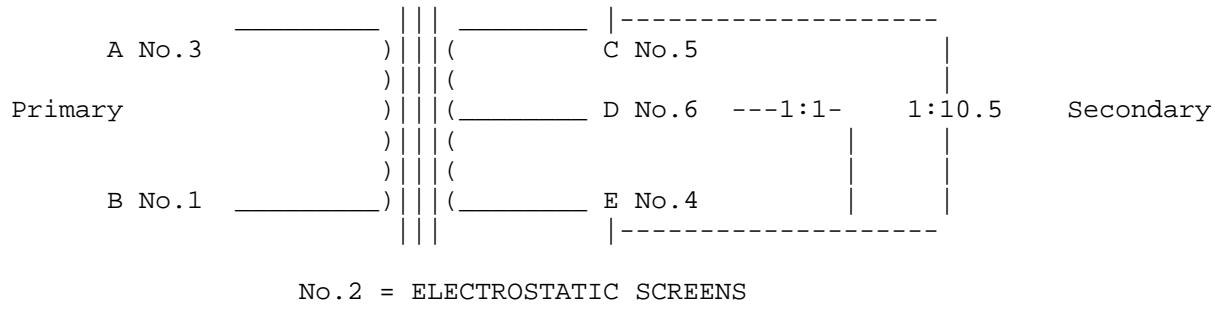

1:1 Ratio = AB : DE

1:10.5 Ratio = AB : CE

7490x Input Transformer 1:10.5 with a 1:1 tap

Ratio 1:10 with tap for 1:1 Max input level +9dBu. Sowter designed transformer replacement for the original Lustraphone transformer. Internal electrostatic shield to ensure good common mode noise rejection. Mumetal can 34 mm diameter

