

7457

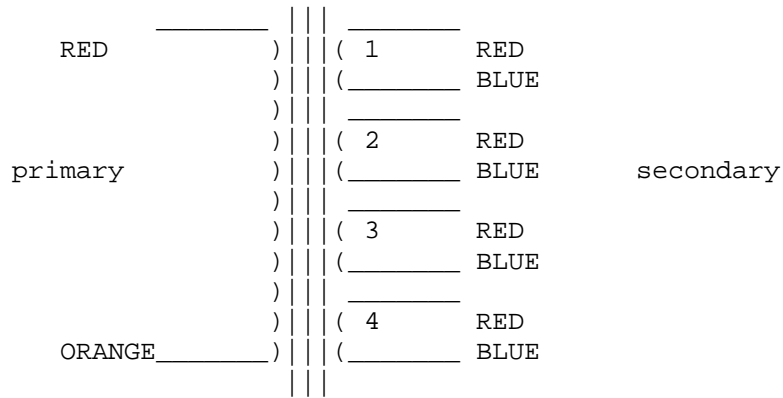

OUTPUT WINDINGS.

There are FOUR EQUAL SECONDARY WINDINGS which can be arranged for loads of 1, 4, 8/9 or 15/16 ohms thus:-

