

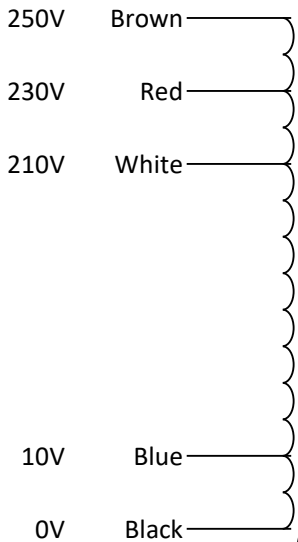

**Connection Diagram**

Type: 0716

**EU Primary**



**WW Primary**

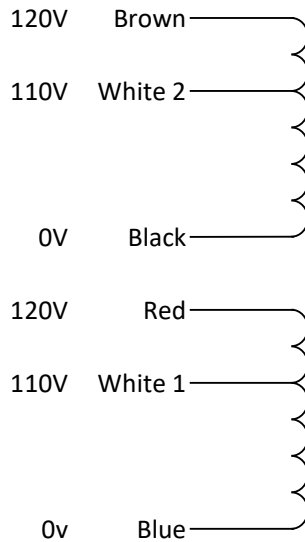

OR

Yel/Grn Electrostatic Screen

Yel/Grn

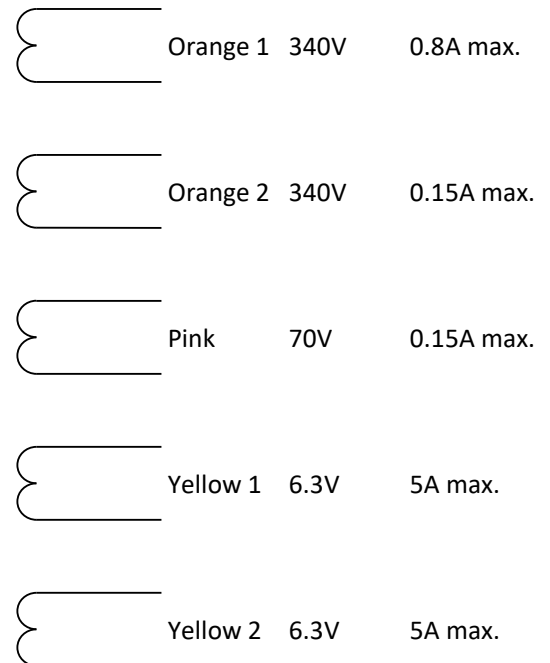

**Notes**

Visual identification – Worldwide version has two white leads, European version has one.

**Worldwide connection options:**

- 110v – N: join Blue and Black, L: join White 1 and White 2, isolate Red and Brown
- 120v – N: join Blue and Black, L: join Red and Brown, isolate White 1 and White 2
- 240v – N: Blue, L: Brown, join Red and Black, isolate White 1 and White 2

**European connection options:**

For mains voltages of 210v, 230v or 250v use Black as Neutral. For 200v, 220v or 240v, use Blue.

ALWAYS isolate all unused leads SEPERATELY FROM EACH OTHER

