

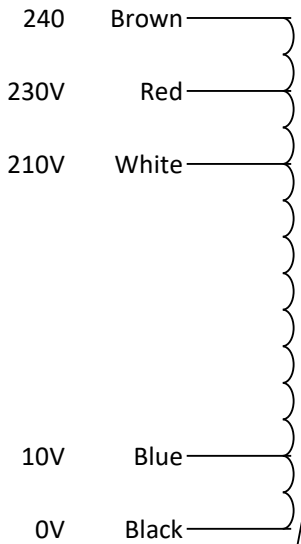

Connection Diagram

Type: 0705

EU Primary



WW Primary

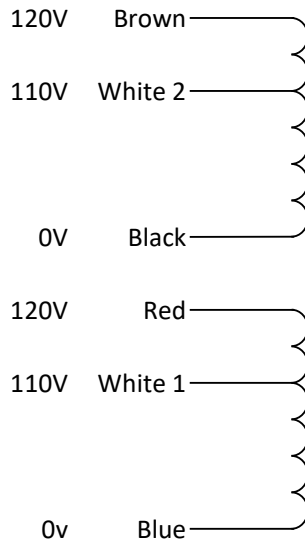

OR

Yel/Grn Electrostatic Screen

Yel/Grn

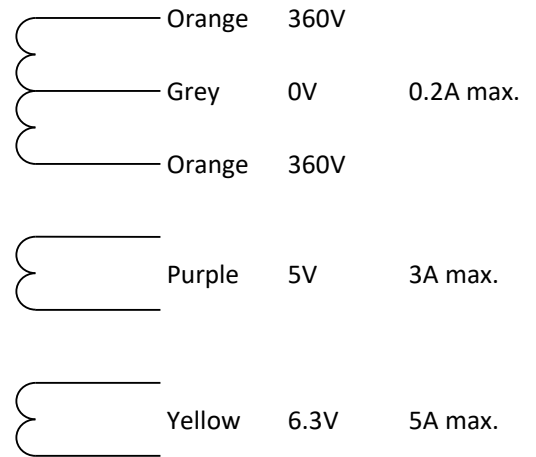

0.2A max.

3A max.

5A max.

Notes

Visual identification – Worldwide version has two white leads, European version has one.

Worldwide connection options:

- 110v – N: join Blue and Black, L: join White 1 and White 2, isolate Red and Brown
- 120v – N: join Blue and Black, L: join Red and Brown, isolate White 1 and White 2
- 240v – N: Blue, L: Brown, join Red and Black, isolate White 1 and White 2

European connection options:

For mains voltages of 210v, 230v or 250v use Black as Neutral. For 200v, 220v or 240v, use Blue.

ALWAYS isolate all unused leads SEPERATELY FROM EACH OTHER