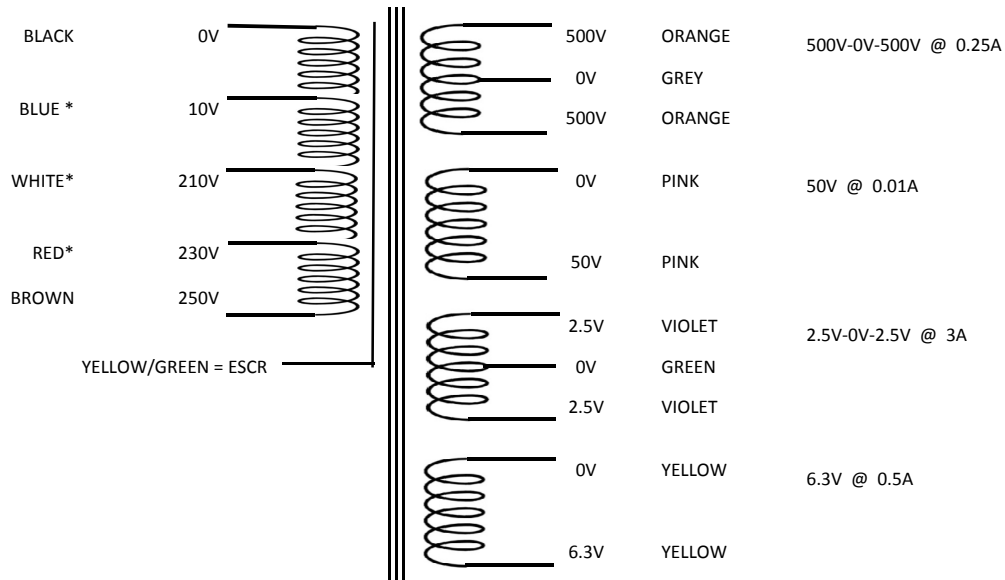

0462

To obtain other inputs use as follows:

10V tap in place of 0V terminal thus:

BLUE/BROWN = 240V BLUE/RED = 220V BLUE/WHITE= 200V

*** FOR PRIMARY WINDING WITH SOLID CORE WIRE AND SLEEVING**

You will note that the Primary is built up in sections and the two wires in the Blue, White and Red sleeves must always be individually joined to make the primary circuit complete. Spare connections not required can be cut short, each colour joined separately and isolated. The solid wire inside the sleeving is coated with polyurethane and needs to be stripped away and tinned if the leads are shortened. For secondary windings with solid core leads please follow the same process.

FOR FLEXIBLE LEADS PRIMARY AND SECONDARY

Just cut short and isolate (INDIVIDUALLY) any spare connections

NOTE: A certain amount of mechanical hum is prevalent in mains transformers and can be amplified when bolting to your metal work. Therefore you may find a small rubber gasket or similar material is worth fitting to quieten this hum to its' minimum, but please ensure the frame is grounded to the supply safety earth.